

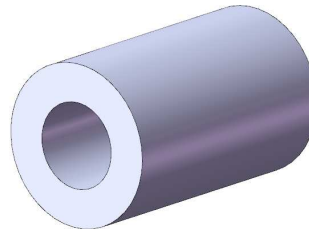

Noms des volumes

a) Volume de révolution

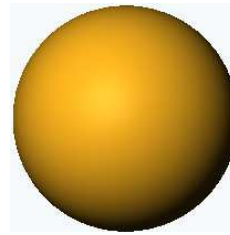
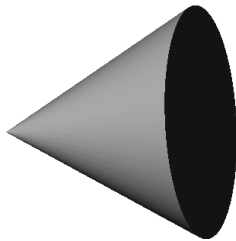
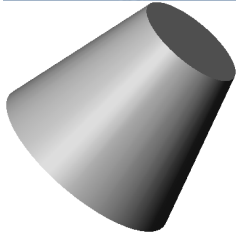
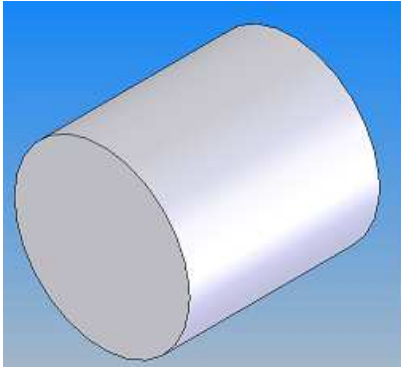

b) Volume de prismatique

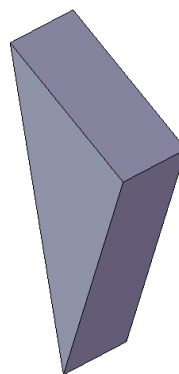
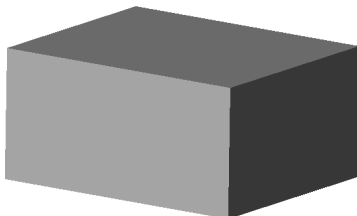
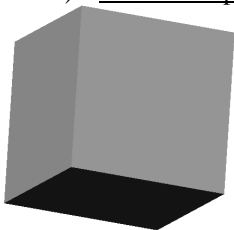

Noms des intersections de volumes

a) _____

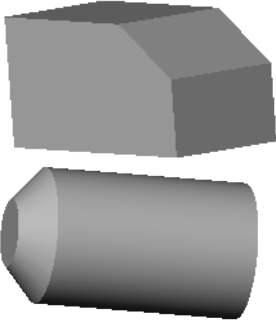

f) _____

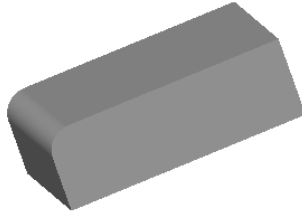

j) _____

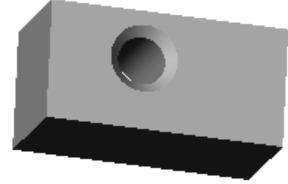

b) _____

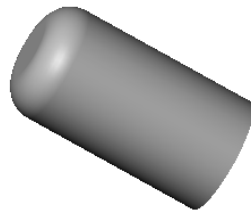

k) _____

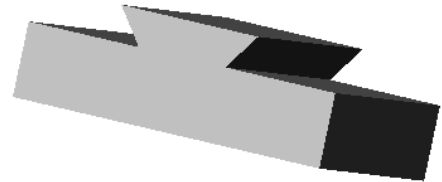

c) _____

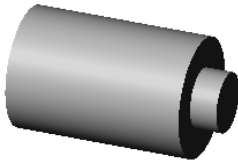

g) _____

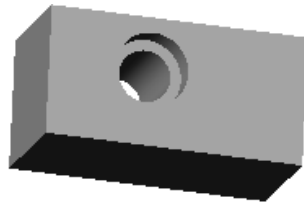

l) _____

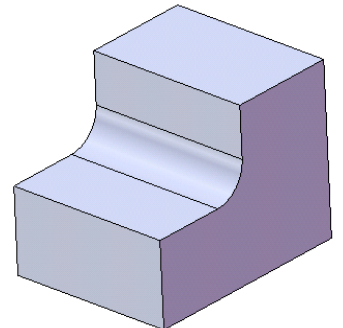

d) _____

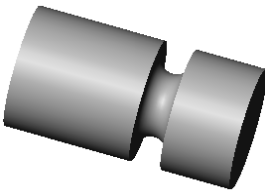

h) _____

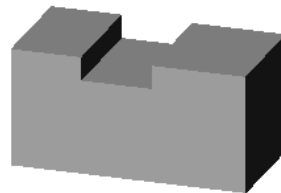

m) _____

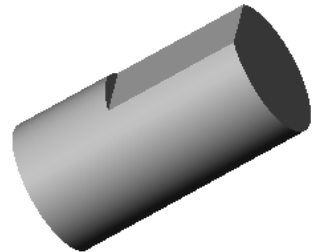

e) _____

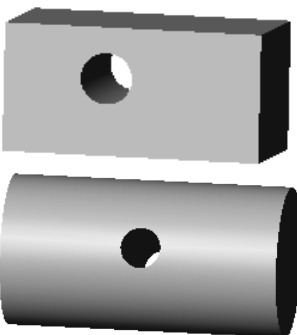

i) _____

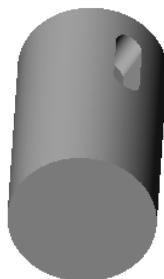

n) _____

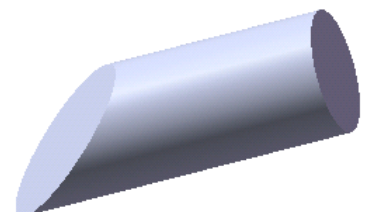

a) Devoirs

/ 5

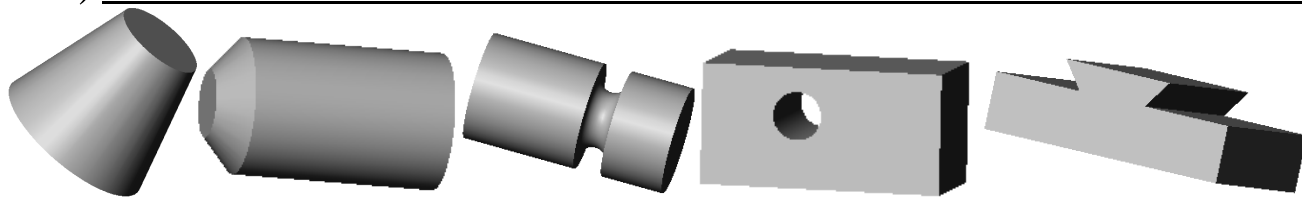

b) Devoirs

/ 5

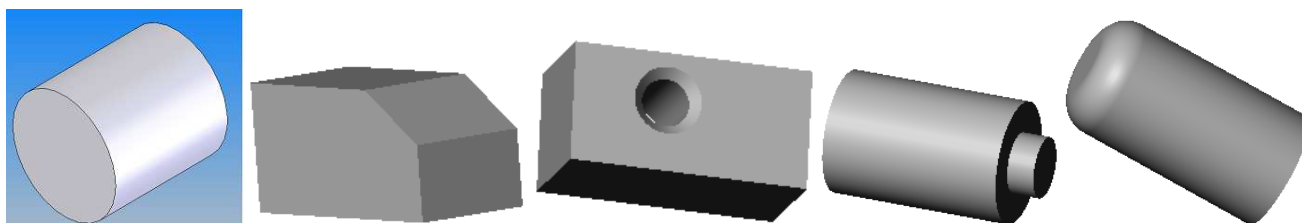

c) Devoirs

/ 5

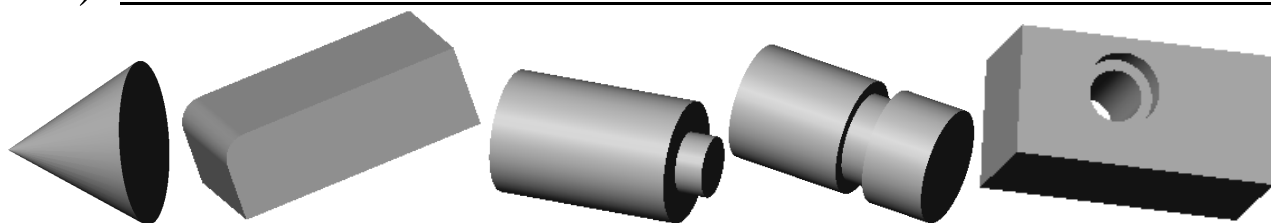

d) Devoirs

/ 5

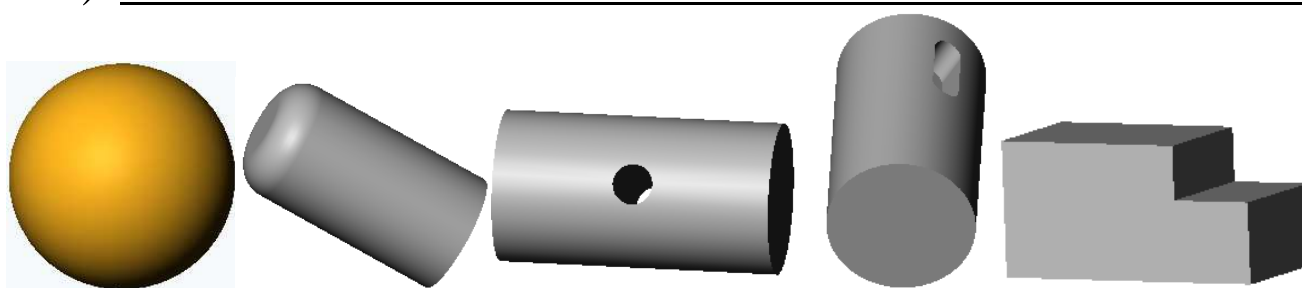

e) Devoirs

/ 5

